

## U.L. Listed Beverage Regulators

Cylinder Gas Pressure (CO<sub>2</sub>)  
Regulators for Soft Drink and  
Beer dispensing systems.

R84 Regulator and C84 Regulator Configurations for Soft Drink Carbonator Service, 1/4" PTF . . . . .	ALE-12-2
R81 Regulator and C81 Regulator Configurations for Soft Drink Dispensing Systems, 1/4" PTF . . . . .	ALE-12-6
R82 Regulator for Beer Dispensing Systems, 1/4" PTF . .	ALE-12-12



**R84**



**R81**



**R82**

- Underwriters Laboratories, Inc. listed (file number SA1089)
- Integral relief valve easily replaced without disassembly of regulator and without affecting relief pressure setting
- Back flow check valve, or manifold with integral check valve at each outlet, can be installed in regulator outlet port. Manifolds available with 3 or 5 outlets and include one outlet cap.
- Relieving diaphragm allows outlet pressure setting to be reduced even though the system is dead-ended. Pressure downstream of check valves will not be reduced.
- Easily replaceable valve cartridge contains valve, valve seat, valve spring, and filter element
- Two high pressure ports (inlet and primary gauge) and two regulated pressure ports (outlet and secondary gauge)
- Bonnet wrench hex same size as tank adapter - one wrench fits both



## Technical Data

Fluid: Carbon dioxide. The R84 regulator is designed to be used exclusively as a carbonator regulator in soft drink dispensing systems to control cylinder gas (carbon dioxide) pressure to the carbonator tank. Other Norgren regulators (R81 for soft drink syrup containers, R82 for beer, R83 for industrial cylinder gases) are available for use in other systems.

Maximum pressure: 3000 psig (207 bar)

Operating temperature: 0° to 140°F (-18° to 60°C)

Integral relief valve cracking pressure:

150 ± 5 psig (10.4 ± 0.33 bar)

Materials:

Body: Brass

Bonnet: Zinc

Valve cartridge: Teflon, brass, stainless steel

Diaphragm: Acetal and nitrile

Relief valve: Brass, polycarbonate, nitrile, aluminum

Seals: Nitrile

## NOTE

The integral relief valve on the R84 regulator does not meet the requirements of Paragraph 4.5c of NSDA Pamphlet TD02, **Installation and Operational Procedures for Pressurized Soft Drink Dispensing Systems**, dated July, 1980. The end cap on the relief valve is color coded red for visual identification and is for use only on the Norgren R84 regulator.

See Section ALE-25 for Accessories







**Ordering Information.** Models listed include integral relief valve with cracking pressure of 150 ± 5 psig (10.4 ± 0.33 bar), PTF threads, relieving diaphragm, 5 to 125 psig (0.34 to 8.6 bar) outlet pressure adjustment range†. A gauge is not included.

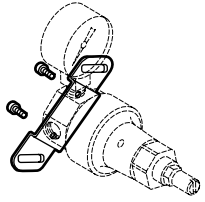

Port	Model	Weight lb (kg)
1/4"	R84-200-MNLA	1.3 (0.59)

† Outlet pressure can be adjusted to pressures in excess of, and less than, that specified. Do not use these units to control pressures outside of the specified range.

**Accessories**

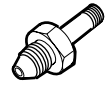
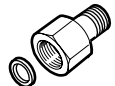
			
Wall Mounting Bracket	Pipe Plug, Hex Socket 1/4" PTF	Hex Nipple 1/4" PTF male	Union Adapter with Cap 1/4" PTF to 1/4" tube (45° flare)
Strap Type: 5095-51	2891-97	18-006-067	18-006-068
			Adapter only: 18-006-027
			Cap only: 3302-50

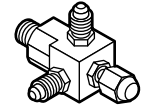
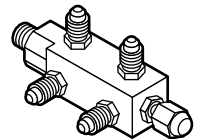
	Inlet Fittings	
		
2" (Ø 50 mm) diameter, 1/4" PTF connection	Nitrogen Service Cylinder Connector 0.906-14 RH external thread	Carbon Dioxide Service Cylinder Connector 0.830-14 RH internal thread
15 psig (1 bar): 18-013-082	CGA No. 580: 18-008-004	1.44" (37 mm) long nipple CGA No. 320: 18-008-002
30 psig (2 bar), UL Listed: 18-013-030		2.25" (57 mm) long nipple 18-008-015
60 psig (4 bar), UL Listed: 18-013-083		Replacement gasket: 1390-02
100 psig (7 bar), UL Listed: 18-013-084		
160 psig (11 bar), UL Listed: 18-013-085		
300 psig (20 bar), UL Listed: 18-013-086		
2000 psig (135 bar), UL Listed: 18-013-244		
3000 psig (205 bar), UL Listed: 18-013-087		

Single Outlet Fittings - Check Valves ††	Multiple Outlet Fittings - Manifolds with integral check valves ††
	<div style="display: flex; justify-content: space-around;"> <div style="text-align: center;">  2 or 3 Port                 </div> <div style="text-align: center;">  4 or 5 Port                 </div> <div style="text-align: center;">  Manifold Extension                 </div> </div>
Check Valve, 1/4" PTF male to 1/4" tube (45° flare): 16-009-001	2 or 3 outlets, 1/4" PTF male to 1/4" tube (45° flare): 3228-54
Check Valve, 1/4" PTF male to 1/2-16 BSF: 16-009-002	2 or 3 outlets, 1/4" PTF male to 1/2-16 BSF: 3228-55
Check Valve, 1/4" PTF male to 1/4" PTF female: 16-009-003	4 or 5 outlets, 1/4" PTF male to 1/4" tube (45° flare): 3228-60
	4 or 5 outlets, 1/4" PTF male to 1/2-16 BSF: 3228-61
	Manifold extension, 1/4" PTF male to 1/4" PTF female: 2340-50

†† The listed check valves and manifolds with integral check valves are designed for use with Norgren R84 regulators and C84 regulator configurations. They are not recommended for use with other regulators and regulator configurations unless separate pressure relief protection is provided in each of the outlet lines.



# R84, C84 Beverage Regulators

**Ordering Information - C84 Regulator Configurations.** Models listed include PTF threads, relieving diaphragm, 5 to 125 psig (0.3 to 8.5 bar) outlet pressure adjustment range†.

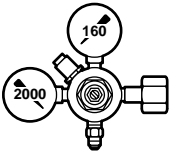
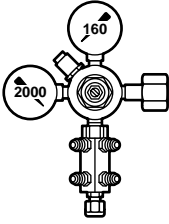
One Outlet Model C84-700	Four or Five Outlets Model C84-666
	
<p><b>Model C84-700 Includes:</b></p> <ul style="list-style-type: none"> <li>● R84-200-MNLA regulator with 150 psig (10.4 bar) integral relief valve (1)</li> <li>● 18-013-244 inlet pressure gauge (1)</li> <li>● 18-013-085 outlet pressure gauge (1)</li> <li>● 18-008-002 cylinder connector (1)</li> <li>● 16-009-001 check valve (1)</li> </ul>	<p><b>Model C84-666 Includes:</b></p> <ul style="list-style-type: none"> <li>● R84-200-MNLA regulator with 150 psig (10.4 bar) integral relief valve (1)</li> <li>● 18-013-244 inlet pressure gauge (1)</li> <li>● 18-013-085 outlet pressure gauge (1)</li> <li>● 18-008-002 cylinder connector (1)</li> <li>● 3228-60 manifold (1)</li> </ul>

† Outlet pressure can be adjusted to pressures in excess of, and less than, those specified. Do not use these units to control pressures outside of the specified ranges.

All Dimensions in Inches (mm)

## R84 Regulator

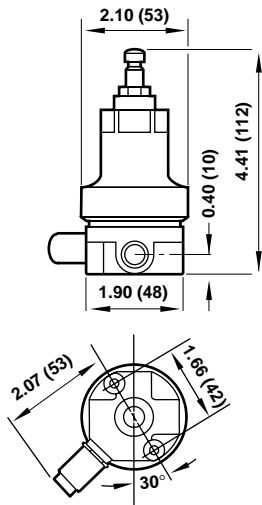

**Mounting Holes (2 Places)**  
0.18" (4.6mm) dia. by 0.39 (10mm) deep.  
Use 10-32 thread forming screws.

## Service Kits

Item	Type	Part number
Service kits	Diaphragm, relieving	570-51
	Valve cartridge and seal	5086-55
	Kit, major	6309-04 *
	Relief valve and seal	5779-54 ††

\* Kit contains diaphragm, slip ring, valve cartridge, and o-rings.

†† Relief valve is marked 150 PSIG RELIEF VALVE and has a brass body with a red end cap.

## 5095-51 Strap Type Bracket

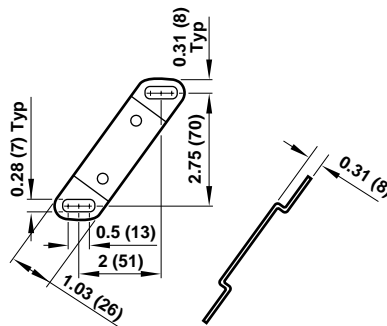



## WARNING

For safety in systems using Norgren Model R84 regulators, the following procedures must be followed.

1. Pressure relief valves of sufficient capacity must always be used in the secondary (outlet) lines downstream of each pressure regulator, whether as an integral part of the regulator, as is the case with Norgren Model R84 Regulator, or separately installed elsewhere in the outlet lines. Do not remove or attempt to adjust, plug, block or otherwise defeat the purpose of the relief valve. Do not replace a relief valve with any but an identical model. The relief valve used on the R84 regulator is preset and marked **150 PSIG RELIEF VALVE**. Replace only with the same 150 psig relief valve, part number 5779-54. The end cap on the 5779-54 relief valve is color coded red for visual identification. Failure to provide a pressure relief valve of sufficient capacity to hold outlet pressure below the lowest working pressure rating of any piece of equipment installed in the outlet lines can result in equipment damage and/or personal injury.
2. A back flow check valve must always be installed at the regulator or at each manifold outlet in liquid dispensing applications to prevent reverse flow through the regulator and possible introduction of liquids and other contaminants into the regulator.
3. Regulators must not be used where temperature or pressure may exceed those specified in the **Technical Data** paragraph.
4. The accuracy of the indication of pressure gauges can change, both during shipment (despite care in packaging) and during the service life. If a pressure gauge is to be used in conjunction with these products and if inaccurate indications may be hazardous to personnel or property, the gauge should be calibrated before initial installation and at regular intervals during use. For gauge standards refer to ANSI B40.1.
5. These regulators are not intended for use in life support systems, beer dispensing systems, with soft drink product (syrup) containers, or industrial cylinder gas systems.

- Underwriters Laboratories, Inc. listed (file number SA1089)
- The R81 regulator and C81 regulator configurations with integral relief valve and outlet check valves meet the requirements of paragraphs 4.5 and 4.6 of NSDA Pamphlet TD02, *Installation and Operational Procedures for Pressurized Soft Drink Dispensing Systems*, dated July, 1980.
- Integral relief valve easily replaced without disassembly of regulator and without affecting relief pressure setting
- Back flow check valve, or manifold with integral check valve at each outlet, can be installed in regulator outlet port. Manifolds available with 3 or 5 outlets and include one outlet cap.
- Relieving diaphragm allows outlet pressure setting to be reduced even though the system is dead-ended. Pressure downstream of check valves will not be reduced.
- Easily replaceable valve cartridge contains valve, valve seat, valve spring, and filter element
- Two high pressure ports (inlet and primary gauge) and two regulated pressure ports (outlet and secondary gauge)
- Diametrically opposite inlet ports facilitate manifolding for multiple dispensing applications. Each manifolded regulator operates independently as though attached directly to the gas supply source.
- Bonnet wrench hex same size as tank adapter - one wrench fits both



Materials:

Body: Brass  
 Bonnet: Zinc  
 Valve cartridge: Teflon, brass, stainless steel  
 Diaphragm: Acetal and nitrile  
 Relief valve: Brass, polycarbonate, nitrile, aluminum  
 Seals: Nitrile

## Technical Data

Fluid: Carbon dioxide. The R81 regulator is designed for use in soft drink dispensing systems to control cylinder gas (carbon dioxide, nitrogen, air) pressure to the product containers. Other Norgren regulators (R84 for soft drink carbonators, R82 for beer, R83 for industrial cylinder gases) are available for use in other systems.

Maximum pressure: 3000 psig (207 bar)

Operating temperature: 0° to 140°F (-18° to 60°C)

Integral relief valve cracking pressure:

130 ± 4 psig (9.0 ± 0.28 bar)

See Section ALE-25 for Accessories



**Ordering Information.** Models listed include integral relief valve with cracking pressure of 130 ± 4 psig (9.0 ± 0.28 bar), PTF threads, relieving diaphragm, 5 to 100 psig (0.34 to 6.9 bar) outlet pressure adjustment range†. A gauge is not included.





Port	Model	Weight lb (kg)
1/4"	R81-200-LNKA	1.3 (0.59)



## Alternative Models

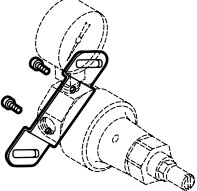

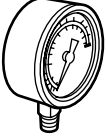

R 8 1 - 2 0 0 - L N ★ A

Outlet Pressure Adjustment Ranges †	Substitute
1 to 25 psig (0.07 to 1.7 bar)	T
2 to 50 psig (0.14 to 3.4 bar)	E
5 to 100 psig (0.34 to 6.9 bar)	K

## Accessories

			
Wall Mounting Bracket	Pipe Plug, Hex Socket 1/4" PTF	Hex Nipple 1/4" PTF male	Union Adapter with Cap 1/4" PTF to 1/4" tube (45° flare)
Strap Type: 5095-51	2891-97	18-006-067	18-006-068
			Adapter only: 18-006-027 Cap only: 3302-50

	Inlet Fittings	
	2" (50 mm) diameter, 1/4 PTF connection	 Nitrogen Service Cylinder Connector 0.906-14 RH external thread CGA No. 580: 18-008-004
15 psig (1 bar): 18-013-082		1.44" (27 mm) long nipple CGA No. 320: 18-008-002
30 psig (2 bar), UL Listed: 18-013-030		2.25" (57 mm) long nipple 18-008-015
60 psig (4 bar), UL Listed: 18-013-083		Replacement gasket: 1390-02
100 psig (7 bar), UL Listed: 18-013-084		
160 psig (11 bar), UL Listed: 18-013-085		
300 psig (20 bar), UL Listed: 18-013-086		
2000 psig (135 bar), UL Listed: 18-013-244		
3000 psig (205 bar), UL Listed: 18-013-087		

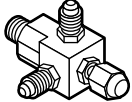
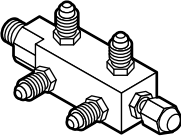
Single Outlet Fittings			Multiple Outlet Fittings		
Check Valve††	Check Valve††	Check and Relief Valve, * Relief cracking pressure: 130 ± 4 psig (9.0 ± 0.28 bar)	2 or 3 Port	4 or 5 Port Manifold Extension	
					
Check Valve, 1/4" PTF male to 1/4" tube (45° flare): 16-009-001	Check Valve, 1/4" PTF male to 1/2-16 BSF: 16-009-002	Check and Relief Valve, 1/4" PTF male to 1/4" tube (45° flare): 16-006-107	Manifolds with integral check valves ††		Streamline Wye **
Check Valve, 1/4" PTF male to 1/4" PTF female: 16-009-003			2 or 3 outlets, 1/4" PTF male to 1/4" tube (45° flare): 3228-54	2 or 3 outlets, 1/4" PTF male to 1/2-16 BSF: 3228-55	1/4" NPT male to 1/4" NPT female: 16-006-107
			4 or 5 outlets, 1/4" PTF male to 1/4" tube (45° flare): 3228-60	4 or 5 outlets, 1/4" PTF male to 1/2-16 BSF: 3228-61	
			Manifold extension, 1/4" PTF male to 1/4" PTF female: 2340-50		

† Outlet pressure can be adjusted to pressures in excess of, and less than, those specified. Do not use these units to control pressures outside of the specified ranges.

†† The listed check valves and manifolds with integral check valves are designed for use with Norgren R81 regulators and C81 regulator configurations. They are not recommended for use with other regulators and regulator configurations unless separate pressure relief protection is provided in each of the outlet lines.

\* The 16-006-107 check and relief valve meets the pressure and flow requirements of paragraphs 4.5 and 4.6 of NSDA Pamphlet TD02, **Installation and Operational Procedures for Pressurized Soft Drink Dispensing Systems**, dated July, 1980.

\*\* Check valves, or manifolds with integral check valves, must be installed in the outlet ports of the wye when the wye is installed in the outlet port of the Norgren R81 regulator.



## R81, C81 Beverage Regulators

### Cylinder Connected, One Regulator Configurations

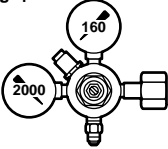
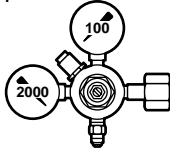
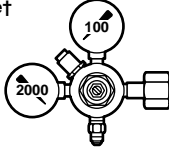
Model C81-700 (One Outlet)	Model C81-702 (One Outlet)	Model C81-651 (One Outlet)
5 to 100 psig range† 	5 to 100 psig range† 	5 to 100 psig range† 
<b>Model C81-700 Includes:</b> <ul style="list-style-type: none"> <li>● R81-200-LNKA regulator (1)</li> <li>● 18-013-244 (2000 psi) inlet pressure gauge (1)</li> <li>● 18-013-085 (160 psi) outlet pressure gauge (1)</li> <li>● 18-008-002 cylinder connector (1)</li> <li>● 16-009-001 check valve (1)</li> </ul>	<b>Model C81-702 Includes:</b> <ul style="list-style-type: none"> <li>● R81-200-LNKA regulator (1)</li> <li>● 18-013-244 (2000 psi) inlet pressure gauge (1)</li> <li>● 18-013-084 (100 psi) outlet pressure gauge (1)</li> <li>● 18-008-002 cylinder connector (1)</li> <li>● 16-009-001 check valve (1)</li> </ul>	<b>Model C81-651 Includes:</b> <ul style="list-style-type: none"> <li>● R81-200-LNKA regulator (1)</li> <li>● 18-013-244 (2000 psi) inlet pressure gauge (1)</li> <li>● 18-013-084 (100 psi) outlet pressure gauge (1)</li> <li>● 18-008-002 cylinder connector (1)</li> <li>● 16-009-002 check valve (1)</li> </ul>

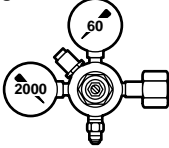
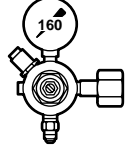
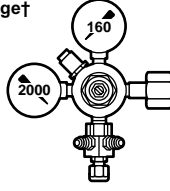
Model C81-269 (One Outlet)	Model C81-684 (One Outlet)	Model C81-685 (Two or Three Outlets)
2 to 50 psig range† 	5 to 100 psig range† 	5 to 100 psig range† 
<b>Model C81-269 Includes:</b> <ul style="list-style-type: none"> <li>● R81-200-LNEA regulator (1)</li> <li>● 18-013-244 (2000 psi) inlet pressure gauge (1)</li> <li>● 18-013-083 (60 psi) outlet pressure gauge (1)</li> <li>● 18-008-002 cylinder connector (1)</li> <li>● 16-009-001 check valve (1)</li> </ul>	<b>Model C81-684 Includes:</b> <ul style="list-style-type: none"> <li>● R81-200-LNKA regulator (1)</li> <li>● 2891-97 pipe plug (1)</li> <li>● 18-013-085 (160 psi) outlet pressure gauge (1)</li> <li>● 18-008-002 cylinder connector (1)</li> <li>● 16-009-001 check valve (1)</li> </ul>	<b>Model C81-685 Includes:</b> <ul style="list-style-type: none"> <li>● R81-200-LNKA regulator (1)</li> <li>● 18-013-244 (2000 psi) inlet pressure gauge (1)</li> <li>● 18-013-085 (160 psi) outlet pressure gauge (1)</li> <li>● 18-008-002 cylinder connector (1)</li> <li>● 3228-54 manifold (1)</li> </ul>

### Cylinder Connected, Two Regulator Configurations

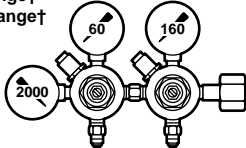
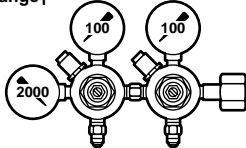
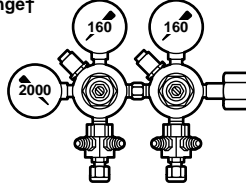
Model C81-254 (Two Outlets)	Model C81-652 (Two Outlets)	Model C81-573 (Four to Six Outlets)
2 to 50 psig range† 5 to 100 psig range† 	5 to 100 psig range† 	5 to 100 psig range† 
<b>Model C81-254 Includes:</b> <ul style="list-style-type: none"> <li>● R81-200-LNEA regulator (1)</li> <li>● R81-200-LNKA regulator (1)</li> <li>● 18-013-244 (2000 psi) inlet pressure gauge (1)</li> <li>● 18-013-083 (60 psi) outlet pressure gauge (1)</li> <li>● 18-013-085 (160 psi) outlet pressure gauge (1)</li> <li>● 18-006-067 hex nipple (1)</li> <li>● 18-008-002 cylinder connector (1)</li> <li>● 16-009-001 check valve (2)</li> </ul>	<b>Model C81-652 Includes:</b> <ul style="list-style-type: none"> <li>● R81-200-LNKA regulator (2)</li> <li>● 18-013-244 (2000 psi) inlet pressure gauge (1)</li> <li>● 18-013-084 (100 psi) outlet pressure gauge (2)</li> <li>● 18-006-067 hex nipple (1)</li> <li>● 18-008-002 cylinder connector (1)</li> <li>● 16-009-002 check valve (2)</li> </ul>	<b>Model C81-573 Includes:</b> <ul style="list-style-type: none"> <li>● R81-200-LNKA regulator (2)</li> <li>● 18-013-244 (2000 psi) inlet pressure gauge (1)</li> <li>● 18-013-085 (160 psi) outlet pressure gauge (2)</li> <li>● 18-006-067 hex nipple (1)</li> <li>● 18-008-002 cylinder connector (1)</li> <li>● 3228-55 manifold (2)</li> </ul>

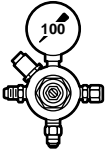
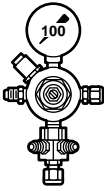
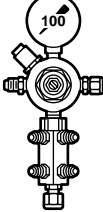

Wall Mounted, One Regulator Configurations

<p>Model C81-541 (One Outlet)</p> <p>5 to 100 psig range†</p> 	<p>Model C81-554 (Two or Three Outlets)</p> <p>5 to 100 psig range†</p> 	<p>Model C81-559 (Four or Five Outlets)</p> <p>5 to 100 psig range†</p> 
<p><b>Model C81-541 Includes:</b></p> <ul style="list-style-type: none"> <li>● R81-200-LNKA regulator with 9,0 bar (130 psig) integral relief valve (1)</li> <li>● 18-013-084 (100 psi) outlet pressure gauge (1)</li> <li>● 18-006-027 half-union adapter (1)</li> <li>● 18-006-068 half-union adapter with cap (1)</li> <li>● 16-009-001 check valve (1)</li> <li>● 5095-51 mounting bracket (1)</li> </ul>	<p><b>Model C81-554 Includes:</b></p> <ul style="list-style-type: none"> <li>● R81-200-LNKA regulator with 9,0 bar (130 psig) integral relief valve (1)</li> <li>● 18-013-084 (100 psi) outlet pressure gauge (1)</li> <li>● 18-006-027 half-union adapter (1)</li> <li>● 18-006-068 half-union adapter with cap (1)</li> <li>● 3228-54 manifold (1)</li> <li>● 5095-51 mounting bracket (1)</li> </ul>	<p><b>Model C81-559 Includes:</b></p> <ul style="list-style-type: none"> <li>● R81-200-LNKA regulator with 9,0 bar (130 psig) integral relief valve (1)</li> <li>● 18-013-084 (100 psi) outlet pressure gauge (1)</li> <li>● 18-006-027 half-union adapter (1)</li> <li>● 18-006-068 half-union adapter with cap (1)</li> <li>● 3228-60 manifold (1)</li> <li>● 5095-51 mounting bracket (1)</li> </ul>

Wall Mounted, Two Regulator Configurations

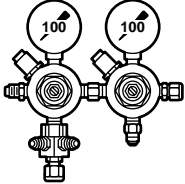
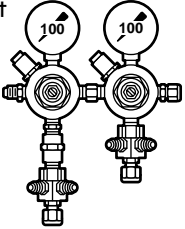
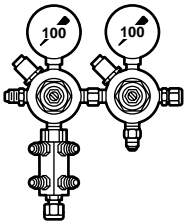
<p>Model C81-540 (Three or Four Outlets)</p> <p>5 to 100 psig range†</p> 	<p>Model C81-570 (Four to Six Outlets)</p> <p>5 to 100 psig range†</p> 	<p>Model C81-657 (Five or Six Outlets)</p> <p>5 to 100 psig range†</p> 
<p><b>Model C81-540 Includes:</b></p> <ul style="list-style-type: none"> <li>● R81-200-LNKA regulator (2)</li> <li>● 18-013-084 (100 psi) outlet pressure gauge (2)</li> <li>● 18-006-067 hex nipple (1)</li> <li>● 18-006-027 half-union adapter (1)</li> <li>● 18-006-068 half-union adapter with cap (1)</li> <li>● 16-009-001 check valve (1)</li> <li>● 3228-54 manifold (1)</li> <li>● 5095-51 mounting bracket (2)</li> </ul>	<p><b>Model C81-570 Includes:</b></p> <ul style="list-style-type: none"> <li>● R81-200-LNKA regulator (2)</li> <li>● 18-013-084 (100 psi) outlet pressure gauge (2)</li> <li>● 18-006-067 hex nipple (1)</li> <li>● 18-006-027 half-union adapter (1)</li> <li>● 18-006-068 half-union adapter with cap (1)</li> <li>● 2340-50 manifold extension (1)</li> <li>● 3228-54 manifold (2)</li> <li>● 5095-51 mounting bracket (2)</li> </ul>	<p><b>Model C81-657 Includes:</b></p> <ul style="list-style-type: none"> <li>● R81-200-LNKA regulator (2)</li> <li>● 18-013-084 (100 psi) outlet pressure gauge (2)</li> <li>● 18-006-067 hex nipple (1)</li> <li>● 18-006-027 half-union adapter (1)</li> <li>● 18-006-068 half-union adapter with cap (1)</li> <li>● 16-009-001 check valve (1)</li> <li>● 3228-60 manifold (1)</li> <li>● 5095-51 mounting bracket (2)</li> </ul>

Wall Mounted, Three Regulator Configuration

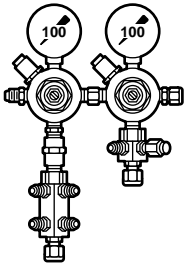
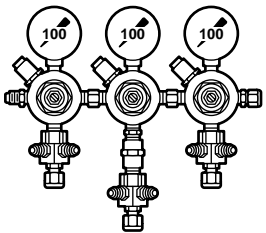
<p>Model C81-724 (Five to Eight Outlets)</p> <p>5 to 100 psig range†</p> 	<p>Model C81-324 (Six to Nine Outlets)</p> <p>5 to 100 psig range†</p> 
<p><b>Model C81-724 Includes:</b></p> <ul style="list-style-type: none"> <li>● R81-200-LNKA regulator (2)</li> <li>● 18-013-084 (100 psi) outlet pressure gauge (2)</li> <li>● 18-006-067 hex nipple (1)</li> <li>● 18-006-027 half-union adapter (1)</li> <li>● 18-006-068 half-union adapter (1)</li> <li>● 2340-50 manifold extension (1)</li> <li>● 3228-56 manifold (1) - Same as 3228-54 but includes two caps</li> <li>● 3228-60 manifold (1)</li> <li>● 5095-51 mounting bracket (2)</li> </ul>	<p><b>Model C81-324 Includes:</b></p> <ul style="list-style-type: none"> <li>● R81-200-LNKA regulator (3)</li> <li>● 18-013-084 (100 psi) outlet pressure gauge (3)</li> <li>● 18-006-067 hex nipple (2)</li> <li>● 18-006-027 half-union adapter (1)</li> <li>● 18-006-068 half-union adapter (1)</li> <li>● 2340-50 manifold extension (1)</li> <li>● 3228-54 manifold (3)</li> <li>● 5095-51 mounting bracket (2)</li> </ul>

† Outlet pressure can be adjusted to pressures in excess of, and less than, those specified. Do not use these units to control pressures outside of the specified ranges.



## R81, C81 Beverage Regulators

All Dimensions in Inches (mm)

### R81 Regulator

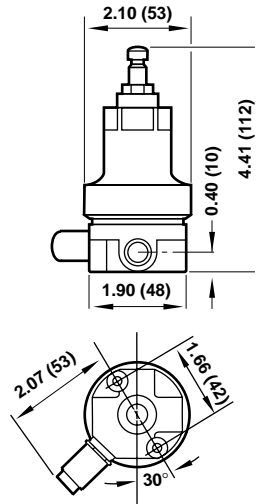

**Mounting Holes (2 Places)**  
 0.18" (4.6 mm) dia. by 0.39 (10 mm) deep.  
 Use 10-32 thread forming screws.

### 5095-51 Strap Type Bracket

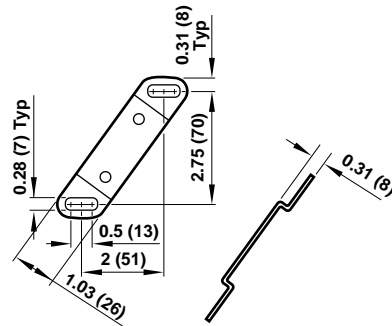

### Service Kits

Item	Type	Part number
Service kits	Diaphragm, relieving	570-51
	Valve cartridge and seal	5086-55
	Kit, major	6309-04 *
	Relief valve and seal	5779-55 †

\* Kit contains diaphragm, slip ring, valve cartridge, and o-rings.

† Relief valve is marked 130 PSIG RELIEF VALVE and has a brass body with a black end cap.



## WARNING

Soft drink dispensing systems must be designed, installed, and operated in accordance with the guidelines set forth in NSDA pamphlet TD02, *Installation and Operational Procedures for Pressurized Soft Drink Dispensing Systems*, dated July, 1980 or subsequent revisions.

1. Pressure relief valves of sufficient capacity must always be used in the secondary (outlet) lines downstream of each pressure regulator, whether as an integral part of the regulator, as is the case with Norgren Model R81 Regulator, or separately installed elsewhere in the outlet lines. Do not remove or attempt to adjust, plug, block or otherwise defeat the purpose of the relief valve. Do not replace a relief valve with any but an identical model. The relief valve used on the R81 regulator is preset and marked **130 PSIG RELIEF VALVE**. Replace only with the same 130 psig relief valve, part number 5779-55. The end cap on the 5779-55 relief valve is color coded black for visual identification. Failure to provide a pressure relief valve of sufficient capacity to hold outlet pressure below the lowest working pressure rating of any piece of equipment installed in the outlet lines can result in equipment damage and/or personal injury.
2. A back flow check valve must always be installed at the regulator or at each manifold outlet in liquid dispensing applications to prevent reverse flow through the regulator and possible introduction of liquids and other contaminants into the regulator.
3. Regulators must not be used where temperature or pressure may exceed those specified in the **Technical Data** paragraph.
4. The accuracy of the indication of pressure gauges can change, both during shipment (despite care in packaging) and during the service life. If a pressure gauge is to be used in conjunction with these products and if inaccurate indications may be hazardous to personnel or property, the gauge should be calibrated before initial installation and at regular intervals during use. For gauge standards refer to ANSI B40.1.
5. These regulators are not intended for use in life support systems, beer dispensing systems, soft drink carbonator systems, or industrial cylinder gas systems.

- Underwriters Laboratories, Inc. listed (file number SA1089)
- The R82 regulator with integral relief valve meets the requirements of Proposed Section 9.7, *Draught Beer Dispensing Equipment and Related Components* (Seventh Draft dated October 17, 1980), of ANSI-ASME F2.1-1975, Food, Drug, and Beverage Equipment.
- Integral relief valve easily replaced without disassembly of regulator and without affecting relief pressure setting
- Back flow check valve, or manifold with integral check valve at each outlet, can be installed in regulator outlet port. Manifolds available with 3 or 5 outlets and include one outlet cap.
- Relieving diaphragm allows outlet pressure setting to be reduced even though the system is dead-ended. Pressure downstream of check valves will not be reduced.
- Easily replaceable valve cartridge contains valve, valve seat, valve spring, and filter element
- Two high pressure ports (inlet and primary gauge) and two regulated pressure ports (outlet and secondary gauge)
- Diametrically opposite inlet ports facilitate manifolding for multiple dispensing applications. Each manifolded regulator operates independently as though attached directly to the gas supply source.
- Bonnet wrench hex same size as tank adapter - one wrench fits both



Materials:

Body: Brass

Bonnet: Zinc

Valve cartridge: Teflon, brass, stainless steel

Diaphragm: Acetal and nitrile

Relief valve: Brass, polycarbonate, nitrile, aluminum

Seals: Nitrile

## Technical Data

Fluid: Carbon dioxide. The R82 regulator is designed for use in beer dispensing systems to control cylinder gas (carbon dioxide) pressure to the beer keg. Other Norgren regulators (R81 for soft drink syrup containers, R84 for soft drink carbonators, R83 for industrial cylinder gases) are available for use in other systems.

Maximum pressure: 3000 psig (207 bar)

Operating temperature: 0° to 140°F (-18° to 60°C)

Maximum outlet pressure adjustment limit: Factory set at 40 to 45 psig (2.8 to 3.1 bar)

Integral relief valve cracking pressure:

60 ± 4 psig (4.1 ± 0.28 bar)





See Section ALE-25 for Accessories





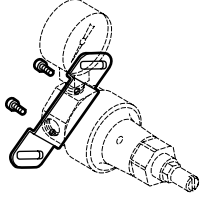

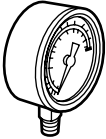

**Ordering Information.** Models listed include integral relief valve with cracking pressure of  $60 \pm 4$  psig ( $4.1 \pm 0.28$  bar), PTF threads, relieving diaphragm, 2 to 45 psig (0.14 to 3.1 bar) outlet pressure adjustment range†. A gauge is not included.

Port	Model	Weight lb (kg)
1/4"	R82-200-ENEA	1.3 (0.59)

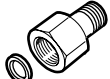
## Accessories

			
Wall Mounting Bracket	Pipe Plug, Hex Socket 1/4" PTF	Hex Nipple 1/4" PTF male	Union Adapter with Cap 1/4" PTF to 1/4" tube (45° flare)
Strap Type: 5095-51	2891-97	18-006-067	18-006-068
			Adapter only: 18-006-027
			Cap only: 3302-50

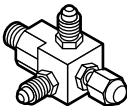
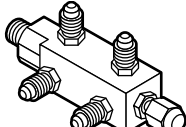
	Inlet Fittings	
		
Ø 50 mm (2") diameter, 1/4" PTF connection	Nitrogen Service Cylinder Connector 0.906-14 RH external thread CGA No. 580: 18-008-004	Carbon Dioxide Service Cylinder Connector 0.830-14 RH internal thread
15 psig (1 bar): 18-013-082		1.44" (37 mm) long nipple CGA No. 320: 18-008-002
30 psig (2 bar), UL Listed: 18-013-030		2.25" (57 mm) long nipple 18-008-015
60 psig (4 bar), UL Listed: 18-013-083		Replacement gasket: 1390-02
100 psig (7 bar), UL Listed: 18-013-084		
160 psig (11 bar), UL Listed: 18-013-085		
300 psig (20 bar), UL Listed: 18-013-086		
2000 psig (135 bar), UL Listed: 18-013-244		
3000 psig (205 bar), UL Listed: 18-013-087		

Single Outlet Fittings - Check Valves ††	Multiple Outlet Fittings - Manifolds with integral check valves ††		
	2 or 3 Port	4 or 5 Port	Manifold Extension
			
Check Valve, 1/4" PTF male to 1/4" tube (45° flare): 16-009-001	2 or 3 outlets, 1/4" PTF male to 1/4" tube (45° flare): 3228-54		
Check Valve, 1/4" PTF male to 1/2-16 BSF: 16-009-002	2 or 3 outlets, 1/4" PTF male to 1/2-16 BSF: 3228-55		
Check Valve, 1/4" PTF male to 1/4" PTF female: 16-009-003	4 or 5 outlets, 1/4" PTF male to 1/4" tube (45° flare): 3228-60		
	4 or 5 outlets, 1/4" PTF male to 1/2-16 BSF: 3228-61		
	Manifold extension, 1/4" PTF male to 1/4" PTF female: 2340-50		

† Outlet pressure can be adjusted to pressures in excess of, and less than, that specified. Do not use these units to control pressures outside of the specified range.

†† The listed check valves and manifolds with integral check valves are designed for use with Norgren R82 regulators. They are not recommended for use with other regulators unless separate pressure relief protection is provided in each of the outlet lines.



## R82 Beverage Regulators

All Dimensions in Inches (mm)

### R82 Regulator

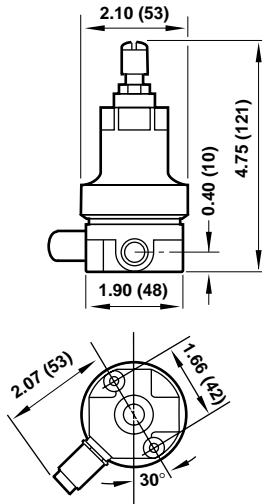

Mounting Holes (2 Places)  
0.18" (4.6 mm) dia. by 0.39" (10 mm) deep.  
Use 10-32 thread forming screws.

### 5095-51 Strap Type Bracket

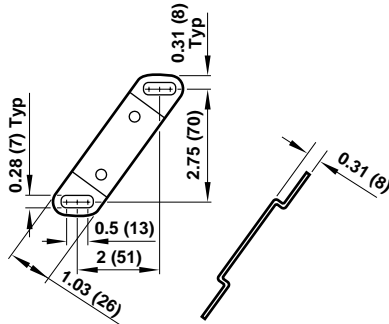

### Service Kits

Item	Type	Part number
Service kits	Diaphragm, relieving	570-51
	Valve cartridge and seal	5086-55
	Kit, major	6309-04 *
	Relief valve and seal	5779-56 †

\* Kit contains diaphragm, slip ring, valve cartridge, and o-rings.

† Relief valve is marked **60 PSIG RELIEF VALVE** and has a brass body with a natural (silver colored) aluminum end cap.

### WARNING

Beer dispensing systems must be designed, installed, and operated in accordance with the applicable guidelines such as the proposed Section 9.7, **Draught Beer Dispensing Equipment and Related Components** (Seventh Draft dated October 17, 1980), of ANSI-ASME F2.1-1975, Food, Drug and Beverage Equipment or subsequent revisions.

- Pressure relief valves of sufficient capacity must always be used in the secondary (outlet) lines downstream of each pressure regulator, whether as an integral part of the regulator, as is the case with Norgren Model R82 Regulator, or separately installed elsewhere in the outlet lines. Do not remove or attempt to adjust, plug, block or otherwise defeat the purpose of the relief valve. Do not replace a relief valve with any but an identical model. The relief valve used on the R82 regulator is preset and marked **60 PSIG RELIEF VALVE**. Replace only with the same 60 psig relief valve, part number 5779-56. The end cap on the 5779-56 relief valve is color coded silver for visual identification. Failure to provide a pressure relief valve of sufficient capacity to hold outlet pressure below the lowest working pressure rating of any piece of equipment installed in the outlet lines can result in equipment damage and/or personal injury.
- A back flow check valve must always be installed at the regulator or at each manifold outlet in liquid dispensing applications to prevent reverse flow through the regulator and possible introduction of liquids and other contaminants into the regulator.
- Regulators must not be used where temperature or pressure may exceed those specified in the **Technical Data** paragraph.
- The accuracy of the indication of pressure gauges can change, both during shipment (despite care in packaging) and during the service life. If a pressure gauge is to be used in conjunction with these products and if inaccurate indications may be hazardous to personnel or property, the gauge should be calibrated before initial installation and at regular intervals during use. For gauge standards refer to ANSI B40.1.
- These regulators are not intended for use in life support systems, soft drink carbonator systems, with soft drink product (syrup) containers, or industrial cylinder gas systems.